

C11A

System socket 11-pole, with white cover and plug-in connector C-A2. (standard delivery)

EC11

Economy socket 11-pole

CS11

Socket 11-pole
Snaped cover sheet with wiring diagram. (backside neutral white)

EC8

Economy socket 8-pole

CS8

Socket 8-pole

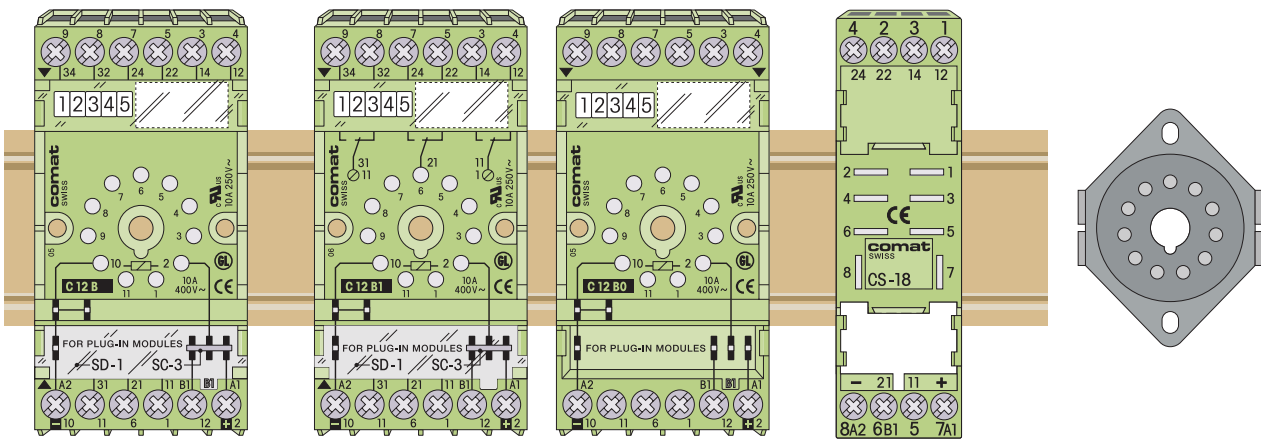

C12B

System Socket 11-pole, 12 terminals (+B1). SC-3 inserted for B1-2-A1. Cover transparent.

C12B1

System Socket 11-pole, like C12B, but with imprinted contact diagram for 3 pole industrial relays.

C12B0

System Socket 11-pole, similar to C12B. Prepared for CT system (without SC-3, SD-1).

CS18

Socket 8-pole for time delay relays C81...C85 series.

11 PGL

Socket 11-pole for chassis mounting with soldering pins.

Socket types		Suitable for product families			Connection layout (from left to the right)
		CT3... CS... C50... C60... RS... C... CX... SSR... CCX...	CT30...CT36	CT2	
C11A	System-Socket	●			A
EC-11	Economy-Socket	●			A
CS-11	Socket	●			B
C12B	System Socket	○	○		A
C12B0	System Socket		●		A
C12B1	System Socket		○		A
CS-18	Socket			●	-
CS-8	Socket			●	-
EC-8	Economy Socket			●	-
11 PGL	Chassis Socket	○			-

A

B

● recommended
○ applicable

Socket accessories		Socket types								
Type	Description	C11A	EC-11	CS-11	C12B	C12B0	C12B1	EC-8	CS-8	CS-18
CA-11	Coding ring (VE 5 pieces)			●						
CA-8	Coding ring (VE 5 pieces)								●	
C-A2	Neutral connector bridge (VE 5 or 50 pieces)	●			●	●	●			
SC-3	A1-Connector (VE 10 pieces)				●	●	●			
LH-1	Marking lable holder (VE 5 pieces)	●			●	●	●			
SL-36	Marking lable holder (VE 5 pieces)			●					●	
SP-36	Marking lable strips (VE 5 pieces)			●					●	
PS-W	Marking lable strips (VE 5 pieces)									●
L-16	Marking lable strips (VE 5 pieces)	●			●	●	●			
SD-1	Cover lid transparent (VE 5 pieces)	●			●	●	●			
SD-1W	Cover lid white	●			●	●	●			
SS-T	Cover transparent									●
SS-W	Cover white									●
SA-0	Wall braket									●

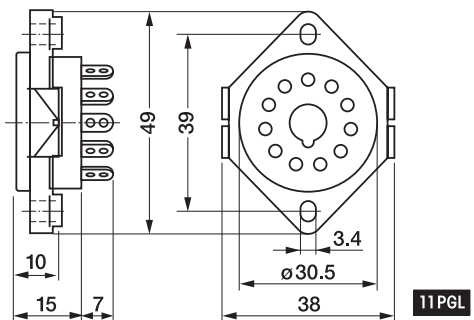
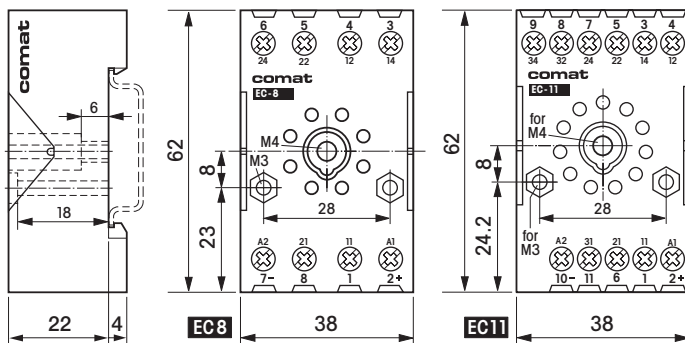
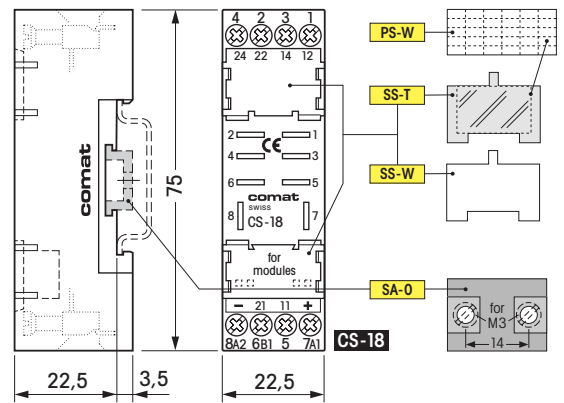
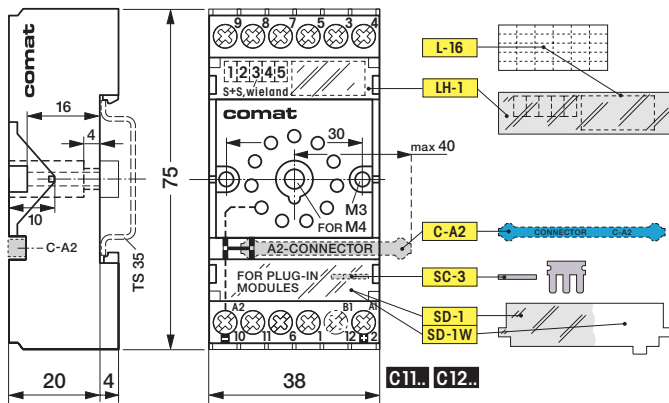
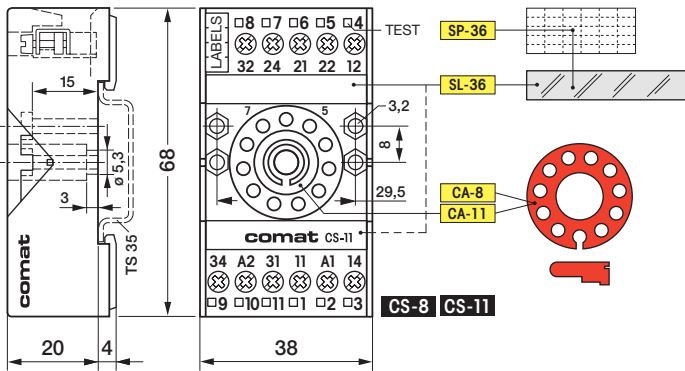

External potentiometer

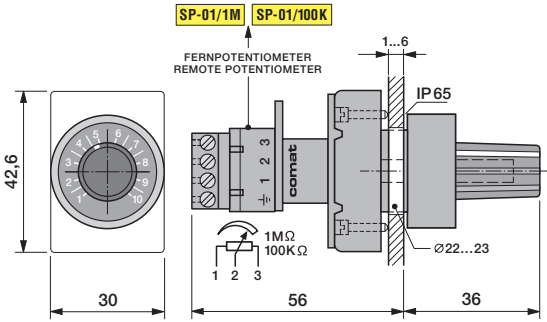

Front panel mounting FZ-50L

Consisting of front frame with cover, retaining clips and socket (11 PGL).

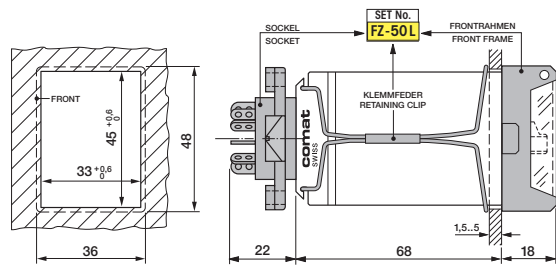

Front panel mounting FZ-23

Consisting of front frame with cover, retaining clips.

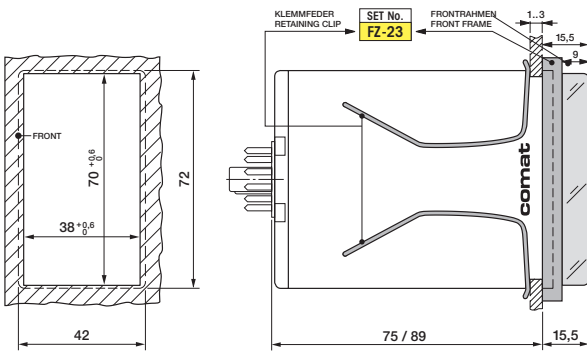

Front panel mounting FZ-40

Consisting of front frame with cover, retaining clips.

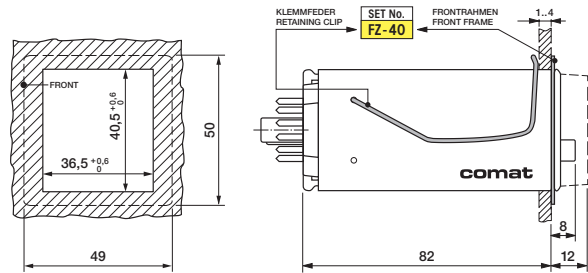

Marking labels

Large and small for relay system C13.

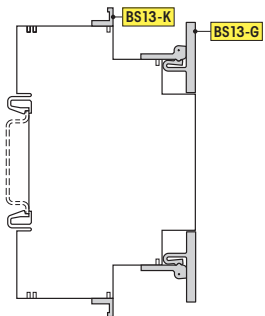

Transparent covers

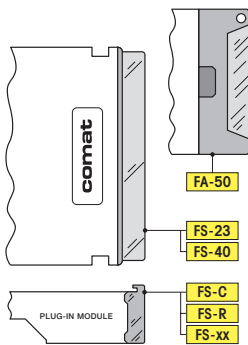

Retaining clips

Matching diverse cases and sockets.

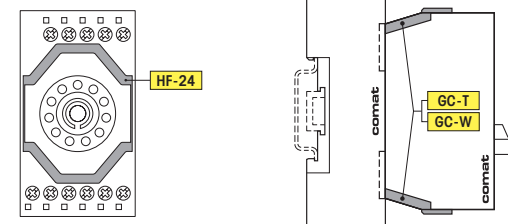

Retaining clips

Matching diverse cases and sockets.

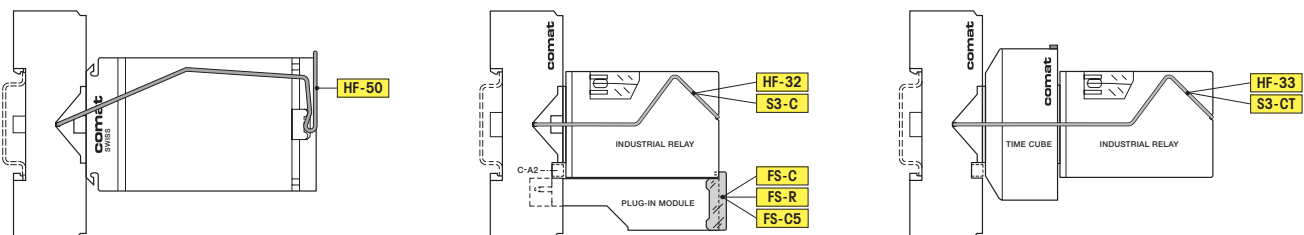

External potentiometer				
Type	Time delay relays			
SP-01/100kΩ	CSV2	CM2		
SP-01/1MΩ	CS1	CS2	RS 121.P	CN 135

Accessories for time delay relays and AP - surface mounting case		Product families															
Type	Descriptions	RS...	C...	CX	CCX	SSR	CS...	C50...	C60...	CT30...	RS 40	CT2...	CT3...	C80...	C13...	DIN A	DIN B/C
BS13-G	Marking label strip large														●		
BS13-K	Marking label strip small														●		
FA-50	Front cover						●										
FS-23	Front cover		●														
FS-40	Front cover										●						
FS-C5	Cover for relay C30									●							
FS-R	Cover for relay C3-..									●							
FS-..	Cover for relay C5-..									●							
FZ-23	Front mounting set		●														
FZ-40	Front mounting set										●						
FZ-50L	Front mounting set (incl. Socket 11PGL)						●										
GC-T	Relay retaining clip transparent													●			
GC-W	Relay retaining clip white													●			
HF-24	Retaining clip		●								●						
HF-32	Retaining clip for relay C30									●							
HF-33	Retaining clip for relay C20/C30											●	●				
HF-50	Retaining clip						●										
S3-C	Retaining clip for relay C3									●							
S3-CT	Retaining clip for relay C2/C3											●	●				
RG	Surface mounting case DIN rail									●				●		●	●
RG-D2	Surface mounting case DIN rail															●	
RG-C2	Surface mounting incl. Socket CS-8											●					
RG-C3	Surface mounting incl. Socket CS-11												●				
RG-50	Surface mounting incl. Socket CS-11						●										
RG-23	Surface mounting incl. Socket CS-11		●														
RG-40	Surface mounting incl. Socket CS-11										●		●				

Surface Mounting Case with built-in DIN rail or with socket (Screws touch safe)
 Gray polymer with or without window.

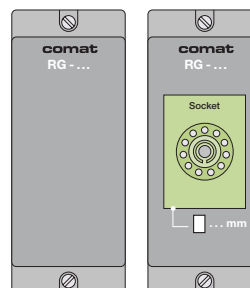
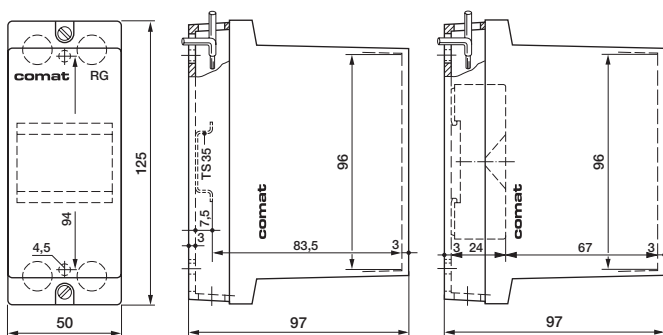

Type	Socket	W x H
RG	DIN	---
RG-D2	DIN	21 x 46 mm
RG-C2	CS-8	36 x 36 mm
RG-C3	CS-11	36 x 36 mm
RG-50	CS-11	36 x 50 mm
RG-23	CS-11	39 x 73 mm
RG-40	CS-11	37 x 40 mm